

Fantom®

Power Pet Bagged Canister

FM765MC 31



U.S.: EURO-PRO Operating LLC
Newton, MA 02459

CANADA: EURO-PRO Operating LLC
4400 Bois Franc
Ville St. Laurent, Québec H4S 1A7
1-800-798-7395
www.fantom.com

COPYRIGHT © EURO-PRO OPERATING LLC 2010

PRINTED IN CHINA REV. 100510

Illustrations may differ from actual product.

IMPORTANT SAFETY INSTRUCTIONS

For Household Use Only

WHEN USING ELECTRICAL APPLIANCES, BASIC SAFETY PRECAUTIONS SHOULD ALWAYS BE FOLLOWED, INCLUDING THE FOLLOWING:

READ ALL INSTRUCTIONS BEFORE USING YOUR CANISTER VACUUM.

POLARIZED PLUG:

To reduce the risk of shock, this appliance has a polarized plug (one blade is wider than the other). As a safety feature, this plug will fit into a polarized outlet only one way. If the plug does not fit fully into the outlet, reverse the plug. If it still does not fit, contact a qualified electrician. **DO NOT modify the plug in any way.**

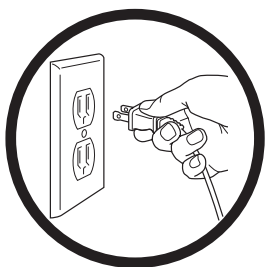

WARNING: To reduce the risk of fire, electrical shock, or injury:

▲ General Electrical Safety:

1. Unplug from electrical outlet when not in use and before servicing.
2. To avoid risk of electric shock, **DO NOT** use vacuum cleaner if it has been dropped, damaged, left outdoors, or dropped into water. **DO NOT** disassemble the appliance. Incorrect reassembly can cause the risk of electric shock when the appliance is used. Return appliance to EURO-PRO Operating LLC for examination, repair or adjustment.
3. The use of an extension cord is not recommended.
4. **DO NOT** use with damaged cord or plug.
5. **DO NOT** pull or carry vacuum by cord.
6. **DO NOT** unplug by pulling on cord. To unplug, grasp the plug, not the cord.
7. **DO NOT** handle plug or vacuum cleaner with wet hands. Before inserting the power plug into the wall outlet, make sure that your hands are dry.
8. **DO NOT** run appliance over cord.
9. **DO NOT** use cord as a handle.
10. **DO NOT** close a door on cord.
11. **DO NOT** pull cord around sharp edges or corners.
12. **DO NOT** leave vacuum cleaner unattended when it is plugged in. Unplug from outlet when not in use.
13. Keep cord away from heated surfaces.
14. **DO NOT** operate the vacuum cleaner close to heaters or radiators.
15. Turn off all controls before plugging in or unplugging the vacuum cleaner.
16. Always unplug this appliance before connecting or disconnecting motorized nozzle.

▲ Hose Attachments:

17. **DO NOT** use if air flow is restricted; if the air paths, the hose or the extension tube become blocked, turn the vacuum cleaner off. Remove all obstructions before you turn the unit on again. Keep free of dust, lint, hair and anything else that may reduce air flow.
18. Keep end of hose, wands and other openings away from your face and body.
19. Keep hair, face, uncovered feet, loose clothing, fingers, and all parts of body away from the rotating brush roll and other openings and moving parts.
20. **DO NOT** operate vacuum cleaner in bare feet or when wearing open toe shoes.
21. Use only manufacturer's recommended attachments.

▲ General Use:

22. This appliance is for household use only.
23. Use only as described in this manual.
24. **DO NOT** use for any purpose other than described in this user's guide.
25. **DO NOT** put any objects into openings. **DO NOT** use with any opening blocked.
26. Keep your work area well lit.
27. Keep the vacuum moving over the carpet surface at all times to avoid damaging the carpet fibers.
28. **DO NOT** place vacuum on unstable surfaces such as chairs or tables. Always keep it on the floor.
29. **DO NOT** allow children to operate the vacuum or use as a toy.
30. Close attention is necessary when used by or near children.
31. Always hold the plug when rewinding the power cord. **DO NOT** allow plug to whip when rewinding.
32. Store your appliance indoors in a cool, dry area.

▲ HEPA Dust Bag/Filters:

33. **DO NOT** use without dust bag and all filters in place.
34. Never operate the vacuum with wet filters.
35. Make sure that the filters are thoroughly dry after routine cleaning.
36. **ONLY** use filters, dust bags and accessories provided by EURO-PRO Operating LLC. (Failure to do so will void the warranty.)

▲ General Cleaning:

37. **DO NOT** run the vacuum over large-sized objects.
38. **DO NOT** pick up hard or sharp objects such as glass, nails, screws, coins, etc.
39. **DO NOT** pick up hot coals, cigarette butts, matches or any hot, smoking, or burning objects.
40. **DO NOT** pick up flammable or combustible materials (lighter fluid, gasoline, kerosene, etc.) or use in the presence of explosive liquids or vapor.
41. **DO NOT** pick up toxic material (chlorine bleach, ammonia, drain cleaner, etc.).
42. **DO NOT** use in an enclosed space where vapors are present from paint, paint thinner, moth proofing substances, flammable dust, or other explosive or toxic materials.
43. **DO NOT** vacuum up any liquids.
44. **DO NOT** immerse the vacuum in water or other liquids.
45. **DO NOT** use outdoors or on wet surfaces. Only use on dry, indoor surfaces.
46. Use extra care when vacuuming on stairs. Always keep the canister vacuum at the bottom of the stairs.

SAVE THESE INSTRUCTIONS



Quick Start

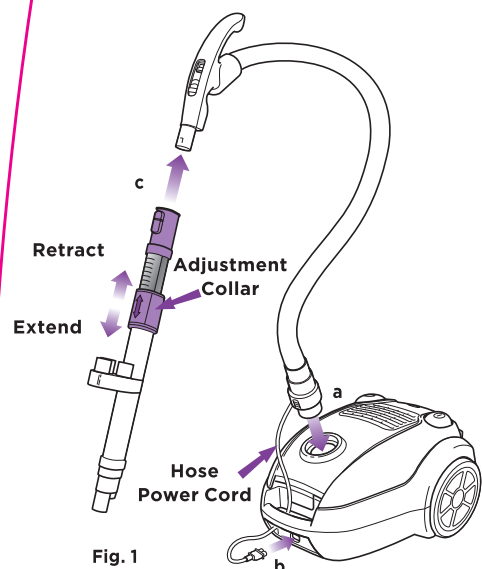

Fig. 1

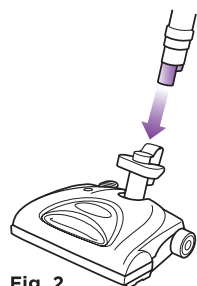

Fig. 2

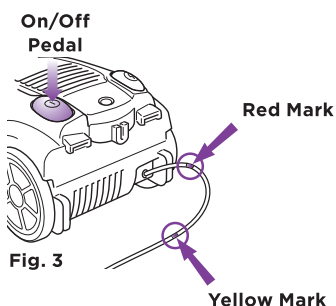

Fig. 3

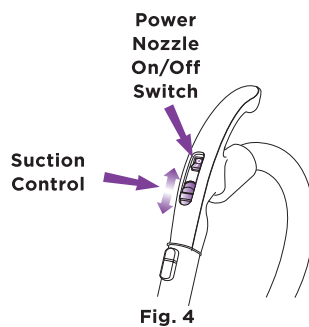

Fig. 4

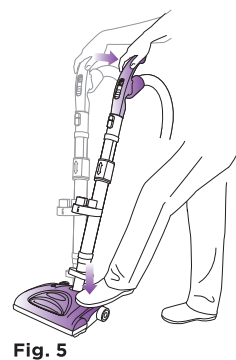

Fig. 5

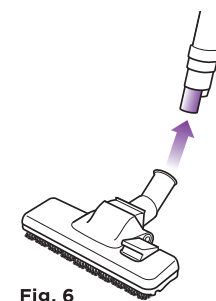

Fig. 6

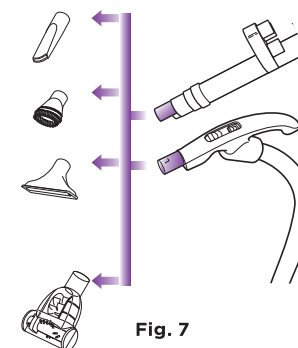

Fig. 7

ASSEMBLING YOUR NEW CANISTER VACUUM

⚠ Make sure the vacuum is turned 'Off' and unplugged before assembling or changing attachments or accessories.

- 1 Ensure that the dust bag and filters are in place. (See 'Maintenance' section.)
- 2 Insert the end of the flexible hose opposite the handle into the air intake duct on the vacuum. (Fig. 1, a)
- 3 Plug the power cord from the hose through the handle into the vacuum. (Fig. 1, b)
- 4 Insert the end of the telescopic tube into the end of the flexible hose handle. (Fig. 1, c)

USING THE POWER NOZZLE

- 1 Insert the telescopic tube into the power nozzle as far as it will go. (Fig. 2)
- 2 Pull the power cord out from the rear of the vacuum and plug it in. **DO NOT** extend past the yellow mark as this indicates the end of the cord is near and **DO NOT** pull beyond the red mark. (Fig. 3)
- 3 First turn the vacuum 'On' by stepping on the On/Off pedal. (Fig. 3)
- 4 Then turn the power nozzle 'On' using the switch on the flexible hose handle. (Fig. 4)
- 5 To begin vacuuming, gently hold the power nozzle down with your foot, keeping it against the floor while you grasp the handle and tilt it towards you. (Fig. 5)

USING THE FLOOR BRUSH

- 1 Push the bare floor nozzle onto the end of the telescopic tube until it is firmly in place. (Fig. 6)
- 2 Plug in the vacuum and turn it 'On'. You can now begin vacuuming.

ABOVE FLOOR CLEANING

- 1 Make sure the vacuum is turned 'Off' and unplugged.
- 2 Firmly push the desired accessory onto the end of either the flexible hose handle or the telescopic tube to clean hard to reach places. (Fig. 7)
- 3 Press the On/Off pedal to start cleaning.
- 4 Open the suction control for low suction when doing light jobs such as drapes or fine surfaces and close it for high suction and when using the hand held turbo. (Fig. 4)



TOLL FREE: 1-800-798-7395

www.fantom.com

**Thank you for
purchasing the
Fantom Power
Pet Bagged
Canister.**

Contents

Getting Started	8
What's Included	8
Assembling Your New Canister Vacuum	9
Using Your New Canister Vacuum	10
Using the Power Nozzle	10
Using the Floor Brush	11
Above Floor Cleaning	12
Properly Storing Your Vacuum	12
Maintenance	13
Changing the Dust Bag	13
Cleaning the Pre-Motor Filter	14
Cleaning the HEPA Filter	15
Clearing Blockages	15
Cleaning the Power Nozzle	16
Changing the Power Nozzle Drive Belt	16
Changing the Power Nozzle Headlight	18
Ordering Parts	18
Troubleshooting	19
Warranty	20
Owner Registration Card	21

TECHNICAL SPECIFICATIONS

Voltage: 120V., 60Hz.

Power: 12 Amps



Getting Started

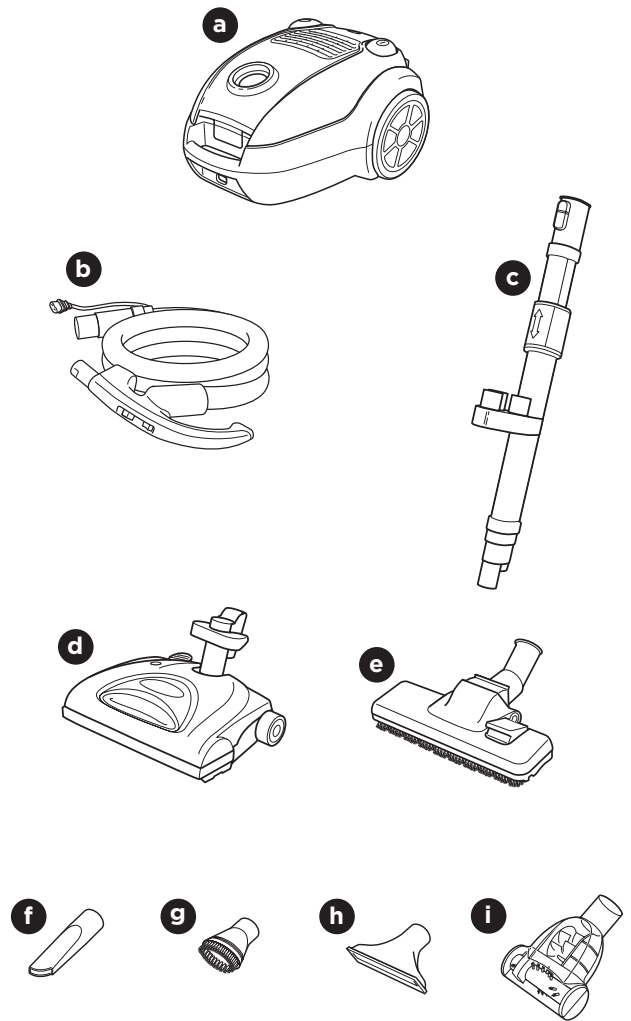

WHAT'S INCLUDED

- a** Vacuum
- b** Flexible Hose Handle
- c** Telescopic Tube
- d** Power Nozzle
- e** Floor Brush
- f** Crevice Tool
- g** Dusting Brush
- h** Upholstery Brush
- i** Hand Held Turbo Brush

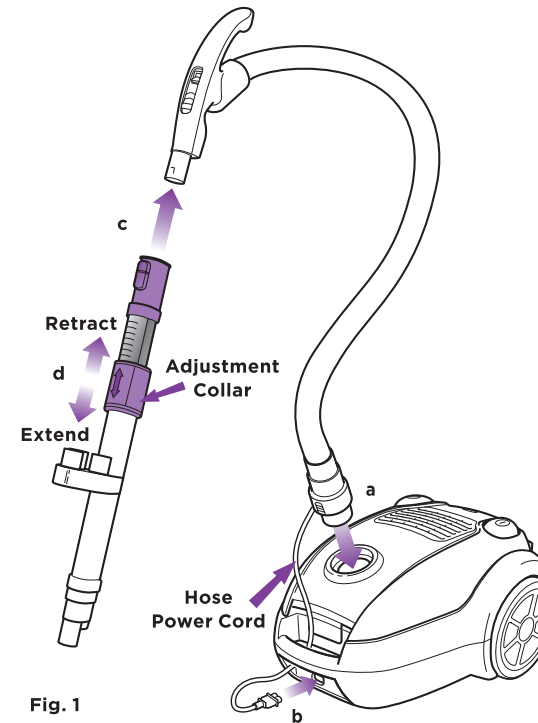

Fig. 1

ASSEMBLING YOUR NEW CANISTER VACUUM

Your canister vacuum is easy to put together.

- 1 Remove all the parts from the packaging and remove any labels, stickers or tags that may be attached to the unit.
 - 2 Ensure that the dust bag and filters are in place. (See 'Maintenance' section.)
 - 3 Insert the end of the flexible hose opposite the handle into the air intake duct on the vacuum. It only fits in one way. Push it in until it locks into place. (Fig. 1, a)
 - 4 Plug the power cord from the hose through the handle into the vacuum. (Fig. 1, b)
 - 5 Insert the end of the telescopic tube into the end of the flexible hose handle. It only fits in one way. Push it in until it locks into place. (Fig. 1, c)
 - 6 To adjust the length of the telescopic tube, hold the adjustment collar, push toward the floor to extend and pull back towards you to retract. (Fig. 1, d)
- How to disassemble:**
- 1 To remove the hose, unplug the power cord, then squeeze the 2 locking tabs together and pull the hose out.
 - 2 To detach the telescopic tube, press and hold the hose handle release button and pull the two pieces apart.
- ⚠ DO NOT** over bend, over stretch, twist or step on the flexible hose as it may crack or break.

Using Your New Canister Vacuum

TIP

Use the carpet height selector pedal to adjust the distance between the floor and the power nozzle to match the type of floor that you are cleaning. The rotating brush must reach the carpet for effective cleaning.

White raises the rotating brush the furthest from the floor.

Blue lowers the rotating brush closest to the floor for maximum cleaning.

If the vacuum is too difficult to push, step on the pedal to select the next highest setting until the vacuum is comfortable to push.

Suggested settings are:

White:	High	shag carpet, long pile, plush, scatter rugs
Yellow:	Med	medium pile
Green:	Low	short pile
Blue:	Floor	bare floor, very low pile

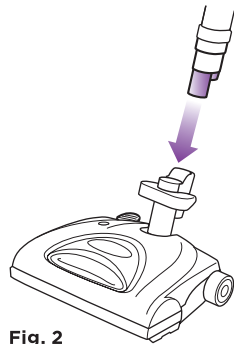

Fig. 2

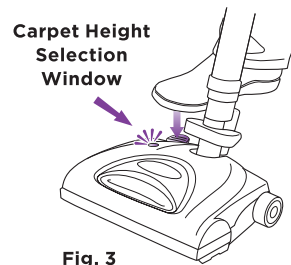

Fig. 3

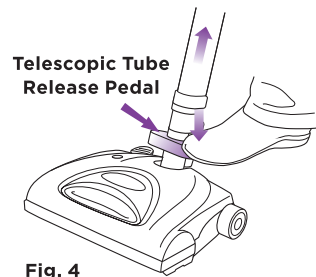

Fig. 4

USING THE POWER NOZZLE

Use the power nozzle to vacuum carpets or rugs.

⚠ Make sure the vacuum is turned 'Off' and unplugged before assembling or changing attachments or accessories.

1 Insert the telescopic tube into the power nozzle as far as it will go. (Fig. 2)

2 Step on the pedal to change the carpet height selection. The color in the carpet height selection window indicates which height you have chosen. (Fig. 3)

NOTE: To remove the telescopic tube from the power nozzle, step on the release pedal and pull the tube out. (Fig. 4)

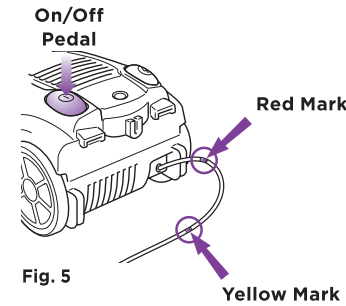

Fig. 5

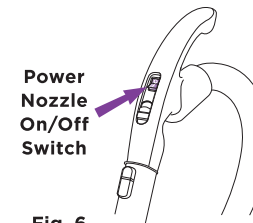

Fig. 6

3 Pull the power cord out from the rear of the vacuum, extend it to the desired length and plug it in. **DO NOT** extend past the yellow mark as this indicates the end of the cord is near and **DO NOT** pull beyond the red mark. (Fig. 5)

4 First turn the vacuum 'On' by stepping on the On/Off pedal. (Fig. 5)

5 Then turn the power nozzle 'On' using the switch on the flexible hose handle. (Fig. 6)

6 To begin vacuuming, gently hold the power nozzle down with your foot, keeping it against the floor while you grasp the handle and tilt it towards you. (Fig. 7)

7 When you have finished vacuuming, turn 'Off' the power nozzle first, then the vacuum and unplug the power cord from the wall. Push the handle back into its upright position.

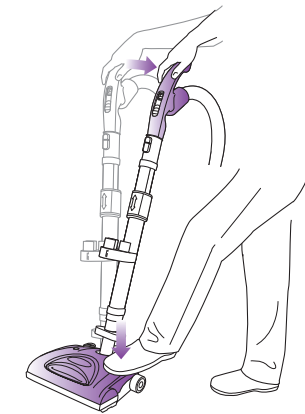

Fig. 7

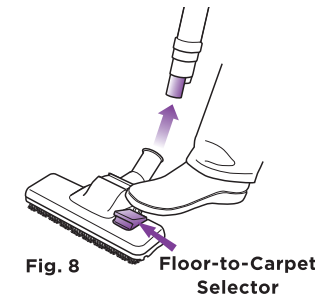

Fig. 8 Floor-to-Carpet Selector

USING THE FLOOR BRUSH

Use the bare floor brush when vacuuming surfaces such as tiles, hardwood and linoleum or convert it to clean carpets and rugs.

1 Push the bare floor nozzle onto the end of the telescopic tube until it is firmly in place. (Fig. 8)

2 Plug in the vacuum and turn it 'On'. You can now begin vacuuming.

3 Push the floor-to-carpet selector forward to use on bare floors. Push it back to use on carpets and rugs. (Fig. 8)

4 When you have finished vacuuming, turn the vacuum 'Off' and unplug the power cord from the wall.

Using Your New Canister Vacuum - cont'd

ACCESSORIES

The **Crevice Tool** can be used to clean radiators, crevices, corners, baseboards and between cushions.

The **Dusting Brush** can be used to dust shelves, lamp shades, Venetian blinds, books and many other surfaces.

The **Upholstery Brush** can be used to clean furniture and other upholstered household items.

This unique **Hand Held Turbo Brush** is designed to remove pet hair from stairs, furniture or upholstery. Maximum air suction is needed in order for the rotating bristle brush to be most effective. Set the suction control on the flexible handle to high. Using a new dust bag and cleaning the filters will also help to keep suction strong.

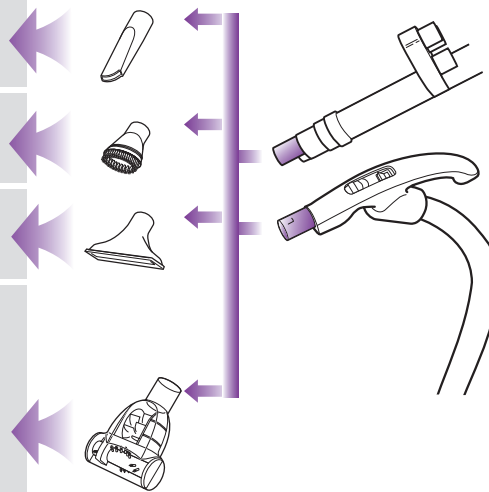

Fig. 9

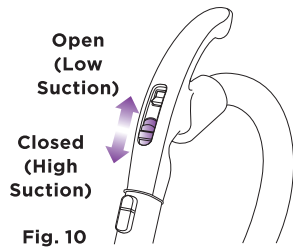

Fig. 10

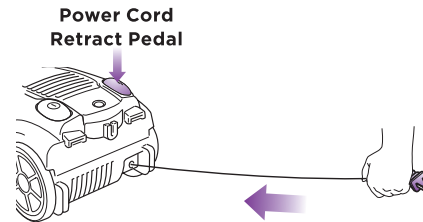

Fig. 11

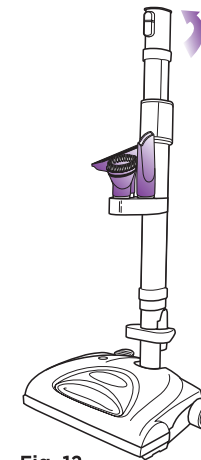

Fig. 12

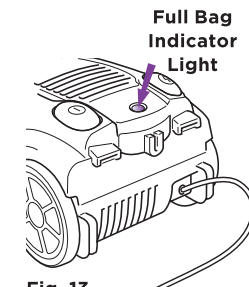

Fig. 13

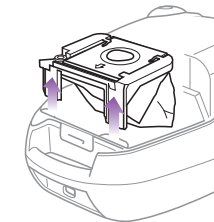

Fig. 14

ABOVE FLOOR CLEANING

- 1 Firmly push the desired accessory onto the end of either the flexible hose handle or the telescopic tube to clean hard to reach places. (Fig. 9)
- 2 Step on the On/Off pedal to start cleaning.
- 3 Adjust the amount of suction with the control on the handle. Open it for low suction when doing light jobs such as drapes or fine surfaces and close it for high suction and when using the hand held turbo. (Fig. 10)
- 4 When you have finished vacuuming, turn the vacuum 'Off' and unplug the power cord from the wall.

PROPERLY STORING YOUR VACUUM

Store your vacuum cleaner safely where it will not be a hazard, will not get damaged and will not cause damage to anyone or anything.

- 1 Unplug the power cord from the wall and hold the cord firmly in your hand while pressing on the power cord retract pedal to reel in the power cord. Slowly feed the power cord back in. If the cord does not fully retract, pull it out an arm's length and try feeding it in again. (Fig. 11)
 - 2 Detach the hose from the telescopic tube and wrap the hose loosely around the vacuum.
 - 3 Clip the floor brush to the back of the vacuum.
 - 4 Store the telescopic tube attached to the power nozzle in the upright position with the accessories on the holder. (Fig. 12)
- ⚠ DO NOT let go of the power cord and allow it to whip around while it rewinds.**

Maintenance

CHANGING THE HEPA DUST BAG

To ensure that your vacuum continues to clean effectively with maximum suction, empty the dust bag as soon as it gets full.

- 1 The full bag indicator light will illuminate when the bag is full. (Fig. 13)
- 2 Turn the vacuum 'Off' and unplug.
- 3 Unplug the hose power cord.
- 4 Push the vacuum cover release lever up and open the cover of the vacuum.
- 5 Lift the dust bag holder straight out. (Fig. 14)

Maintenance

⚠ To reduce the risk of electric shock, unplug the unit before performing any cleaning, maintenance or troubleshooting checks. Failure to do so may result in electric shock or personal injury.

COMPONENT	MAINTENANCE SCHEDULE
HEPA Dust Bag	Replace when full. DO NOT REUSE.
Pre-Motor Filter	Rinse and dry every month under normal use.
HEPA Filter	Tap clean every time you replace the dust bag. Rinse and dry every 3 - 6 months under normal use. Replace once a year depending on usage.

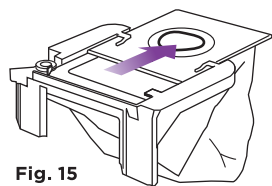

Fig. 15

6 Slide the dust bag out of the holder, taking care not to spill any dirt, and throw the bag away. (Fig. 15)

⚠ **NEVER** reuse the dust bag.

7 Replace the dust bag by sliding it into the holder with the opening on top and the arrow pointing in the direction that it is sliding.

8 Gently slide the holder back into its grooves as far as it will go and close the cover.

NOTE: If the cover does not close it is because the bag holder is not installed properly. **Do not force the cover shut.** Take the holder out and re-install it properly.

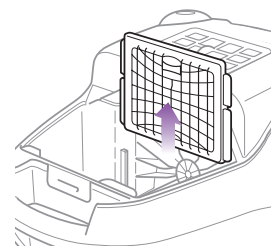

Fig. 16

CLEANING THE PRE-MOTOR FILTER

Check the pre-motor filter when changing the dust bag.

- 1 Remove the dust bag.
 - 2 Slide the filter tray up to remove. (Fig. 16)
 - 3 Pull the filter out of the tray and rinse both the tray and filter in lukewarm water.
 - 4 Let the parts air dry completely for 24 hours.
 - 5 When dry, re-insert the filter back into the tray and slide the tray back into its grooves with the arrows on the tray pointing in the direction that it is sliding.
- ⚠ The pre-motor filter should be replaced every 3-6 months depending on use.

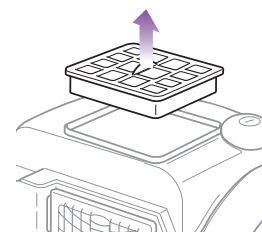

Fig. 17

CLEANING THE HEPA FILTER

Air goes through this final filtration system to reduce dust before coming back into your home. Wash the HEPA filter at the same time as you wash your pre-motor filter.

- 1 Open the cover.
 - 2 Pull the filter straight out to remove. (Fig. 17)
 - 3 Turn the HEPA filter over so that the dirty side is on the bottom and vigorously tap it clean against a garbage can to remove any dust.
 - 4 Rinse in lukewarm water.
 - 5 Let the filter air dry completely for 24 hours.
 - 6 When dry, re-insert the filter back into the vacuum.
- ⚠ The HEPA filter should be replaced once every 12 months depending on use.
- ⚠ Never operate the vacuum without the dust bag and filters in place.
- ⚠ Never operate the vacuum with wet filters.
- ⚠ **DO NOT** wash filters in the dishwasher or washing machine. **DO NOT** use a hair dryer to dry them. Air dry only.

TIP

Use a flashlight to help search for blockages.

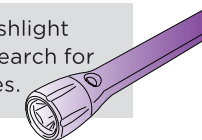

CHECKING FOR BLOCKAGES

Occasionally the vacuum may become blocked by a build up of debris. If you suspect there is a blockage, it is important to locate where it is and carefully remove it without causing damage to yourself, the unit or anything else. Perform the following steps to try to find the blockage.

- 1 Detach the power nozzle, floor brush or accessory from the end of the tube and inspect inside each of the accessories and the floor attachments.
 - 2 Turn the hand held turbo brush over to inspect the opening underneath and the rotating bristle brush. Remove any debris and carefully, without damaging the bristles or belt, cut any build-up of hair or string wrapped around the rotating bristle brush with scissors.
 - 3 Detach the flexible hose, straighten it out, detach the telescopic tube and inspect inside the hose, the handle, the tube and the air intake duct.
- ⚠ Beware of sharp objects when clearing blockages.
- ⚠ Damages caused while clearing or attempting to clear blockages are not covered under your product's limited warranty.
- ⚠ Replace parts securely before using again.



Maintenance - cont'd

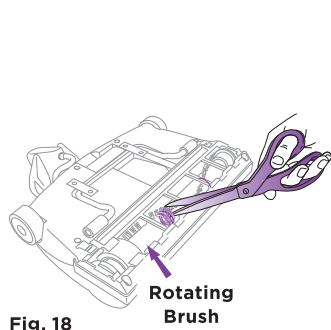

Fig. 18

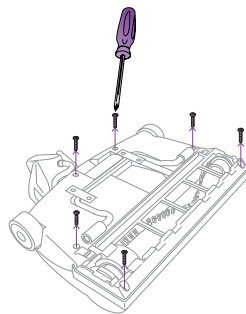

Fig. 19

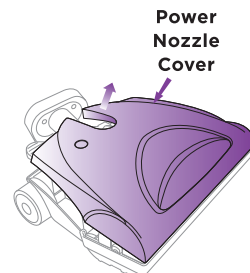

Fig. 20

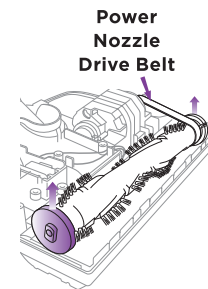

Fig. 23

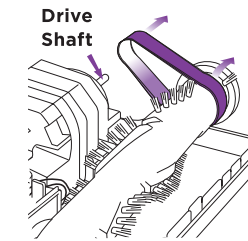

Fig. 24

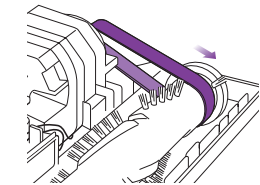

Fig. 25

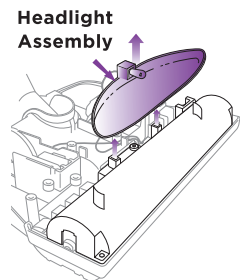

Fig. 21

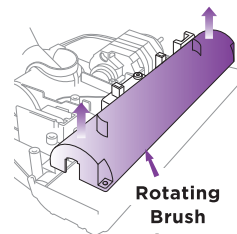

Fig. 22

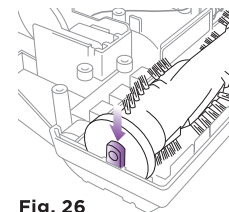

Fig. 26

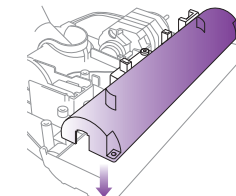

Fig. 27

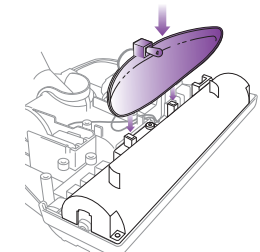

Fig. 28

CLEANING THE POWER NOZZLE

The rotating brush must be free of debris for effective cleaning and maximum suction.

- 1 Disconnect the power nozzle and turn it over to inspect the bottom. If a build-up of debris is wound around the rotating brush, remove by carefully cutting with scissors. Avoid damaging or cutting the bristles. (Fig. 18)

CHANGING THE POWER NOZZLE DRIVE BELT

Depending on how much your vacuum is used, the power nozzle drive belt will occasionally require changing.

- 1 Disconnect the power nozzle and turn it over.
- 2 Using a Phillips screwdriver, remove the six (6) screws from the bottom plate. (Fig. 19)
- 3 Turn the power nozzle over and remove the power nozzle cover. (Fig. 20)
- 4 Carefully lift up the headlight assembly (Fig. 21)
- 5 Remove the rotating brush cover. (Fig. 22)

- 6 First lift up the left end of the rotating brush with no belt and then the right end where the belt loops around. (Fig. 23)
- 7 Slide the old belt off the drive shaft and then the rotating brush. If the belt is broken, remove all the broken pieces. (Fig. 24)
- 8 Place the new belt over the rotating brush first and then over the drive shaft. Make sure the lettering on the belt is on the outside.

- 9 Grasp the right side of the rotating brush and pull it forward, stretching the belt. Insert the end of the brush into the hole and hold it in place with your right hand. (Fig. 25)
- 10 Secure the left side of the rotating brush into place by sliding the end down into the slot. This end will only fit back into place one way. You may have to rotate the end piece so that it fits. (Fig. 26)
- 11 Replace the rotating brush cover. (Fig. 27)
- 12 Replace the headlight assembly onto the rotating brush cover making sure that the pins in the assembly fit into the slots in the cover. (Fig. 28)

Maintenance - cont'd

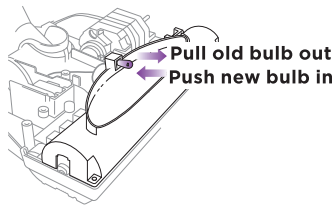

Fig. 29

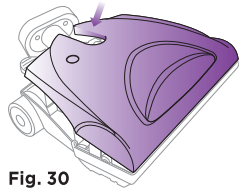

Fig. 30

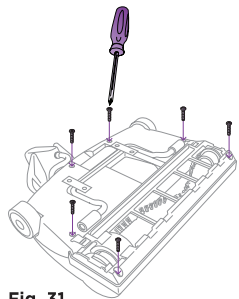

Fig. 31

CHANGING THE POWER NOZZLE HEADLIGHT

Occasionally, the headlight will need changing if it burns out.

- 1 Hold the light bulb securely with your fingers and pull it out. Hold the new bulb and push it in to replace it. (Fig. 29)
- 2 Replace the power nozzle cover. Be careful not to catch and squeeze any loose wires when pushing the cover back into place. (Fig. 30)
- 3 Turn the power nozzle over and replace the six (6) screws. (Fig. 31)

Ordering Parts

To order additional parts for your canister vacuum, feel free to contact us at www.fantom.com or call 1-800-798-7395.

PART	PART NO.
1 HEPA Dust Bag (x 3)	XSB765
2 Filter Kit	XSH765
3 Power Nozzle Drive Belt (x 2)	XL765
4 Power Nozzle Headlights (x 2)	1079FC

Troubleshooting

PROBLEM	SUGGESTED ACTION
Vacuum Shut Off Due to Overheating (motor protective thermostat automatically turned off unit)	<p>Reset Motor Thermostat:</p> <ol style="list-style-type: none"> 1. Push the On/Off pedal once. 2. Unplug the unit. 3. Check the source of the overheating problem (i.e. clogged hose or filter, full bag). Unclog the hose, change bag and clean the filters if necessary. 4. Wait at least 45 minutes before attempting to reuse the vacuum. After the unit has cooled down for 45 minutes, plug in the vacuum cleaner and step on the On/Off pedal. The vacuum should start again. 5. If the vacuum still does not start, contact customer service at 1-800-798-7395.
Vacuum Won't Run	<ol style="list-style-type: none"> 1. Plug in firmly. 2. Reset circuit breaker or replace fuse. 3. Step on On/Off pedal to turn on. 4. Reset motor thermostat.
Vacuum Won't Pick Up	<ol style="list-style-type: none"> 1. Put in a new HEPA dust bag. 2. Adjust carpet height setting. 3. Remove obstruction from air path. 4. Replace belt if broken. 5. Push telescopic tube and flexible hose in securely. 6. Push floor attachment or accessory in securely. 7. Clean/change filters.
Vacuum Picks Up Moveable Rugs Or Pushes Too Hard	<ol style="list-style-type: none"> 1. Adjust carpet height setting.
Rotating Brush Does Not Turn	<ol style="list-style-type: none"> 1. Replace belt. 2. Check belt changing instructions.
Air Flow Restricted With Attachment, Sound of Vacuum Changes	<ol style="list-style-type: none"> 1. Open the manual suction control on the handle of the flexible hose. 2. Remove obstruction in air path.
Cord Does Not Rewind	<ol style="list-style-type: none"> 1. Straighten or un-knot the cord.

Model
FM765MC 31



EURO-PRO TWO-YEAR (2) LIMITED WARRANTY

EURO-PRO Operating LLC warrants this product to be free from material defects and workmanship for a period of two (2) years from the date of purchase when utilized for normal household use, subject to the following conditions, exclusions and exceptions.

The liability of **EURO-PRO Operating LLC** is limited solely to the cost of the repair or replacement of the unit at our option. This Limited Warranty does not cover normal wear of parts and does not apply to any unit that has been tampered with or used for commercial purposes. This Limited Warranty does not cover damage caused by misuse, abuse, negligent handling or damage due to faulty packaging or mishandling in transit. This Limited Warranty does not cover damage or defects caused by or resulting from damages from shipping or repairs, service or alteration to the product or any of its parts, which have been performed by a repair person not authorized by **EURO-PRO Operating LLC**.

If your appliance fails to operate properly while in use under normal household conditions within the warranty period, you may return the complete appliance and accessories with proof of purchase and date, freight prepaid. For customer service support, call 1-800-798-7395 or visit our website at www.fantom.com.

If the appliance is found by **EURO-PRO Operating LLC** to be defective, in **EURO-PRO Operating LLC's** sole discretion, we will repair or replace it free of charge. Proof of purchase date and a check made payable to **EURO-PRO Operating LLC** in the amount of \$19.95 to cover the cost of return shipping and handling must be included.*

Non-durable parts including, without limitation, bags, filters, brushes and electrical parts which normally require replacement are specifically excluded from warranty. This Limited Warranty is extended to the original purchaser of the unit and excludes all other legal, implied and/or conventional warranties. The responsibility of **EURO-PRO Operating LLC** if any, is limited to the specific obligations expressly assumed by it under the terms of this Limited Warranty. **In no event is EURO-PRO Operating LLC** liable for incidental or consequential damages to anyone of any nature whatsoever. Some states do not permit the exclusion or limitation of incidental or consequential damages, so the above may not apply to you.

This Limited Warranty gives you specific legal rights, and you may also have other rights which vary from state to state or province to province.

***IMPORTANT: Carefully pack item to avoid damage in shipping. Be sure to include proof of purchase date and to attach a tag to item before packing including your name, complete address and phone number with a note giving purchase information, model number and what you believe is the problem with the item. We recommend you insure the package (as damage in shipping is not covered by your warranty). Mark the outside of your package "ATTENTION CUSTOMER SERVICE". We are constantly striving to improve our products, therefore the specifications contained herein are subject to change without notice.**

OWNERSHIP REGISTRATION CARD FOR CANADIAN CONSUMERS ONLY

Please fill out and mail the product registration card within ten (10) days of purchase. The registration will enable us to contact you in the unlikely event of a product safety notification. By returning this card you acknowledge to have read and understood the instructions for use, and warnings set forth in the accompanying instructions.

Mail to the following address:

- EURO-PRO Operating LLC
4400 Bois Franc, Ville St. Laurent, Québec, Canada H4S 1A7

Owner's Name:

Address:

City: Province: Postal Code:

<input type="text"/>	<input type="text"/>	<input type="text"/>
----------------------	----------------------	----------------------

Date Purchased:

Name of Store:

Appliance Model:



fantom